

Checkpoint Original[®]

Checkpoint[®] is the first ever wheel nut indicator with wheel overheating indication.

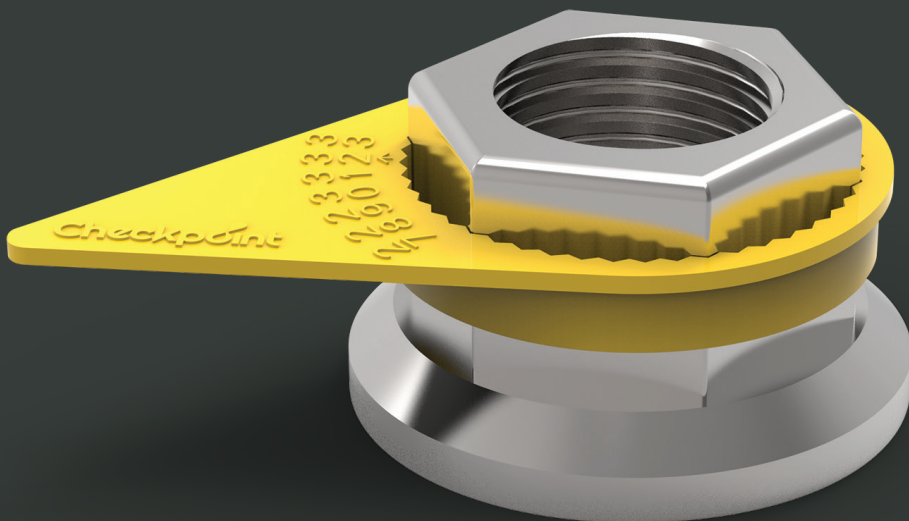

AVAILABLE

Colour	Size (mm)
Fluro Yellow	13
	14
Red	15
	16
Solid Yellow	17
	18
Green	19
	20
Orange	21
	22
Blue	23
	24
Olive Grey	25
	26
Black	27
	28
Silver Grey	29
	30
White	31
	32
	33
	34
	35
	36
	37
	38
	39
	40
	41
	42
	43
	44
	45
	46
	47
	48
	49
	50
	51
	52
	53
	54
	55
	56
	57
	58
	59
	60
	61
	62
	63
	64
	65
	66
	67
	68
	69
	70

Checkpoint Original®

Product: Checkpoint® Yellow 25mm
Product Code: CPY25

Function: The Checkpoint® visually indicates wheel nut movement. It will also melt to highlight any overheating issues with the wheel.

Material: We use high-grade virgin polymer to ensure product quality and reliability as an overheating indicator.

Melt temperature:

125°C/257°F (standard version).

165°C/329°F (HT version).

For higher temperatures please contact us for further information.

Application: Mainly for commercial vehicles such as trucks, agricultural vehicles, dangerous goods transporters, etc. It is also used in the industrial sector, and wherever safety critical fasteners can loosen due to heavy vibrations.

Main benefits: Improves the safety of nut fittings. Enables quick and easy visual checks and monitoring. Reduces maintenance costs by saving time and money.

Sizes: All sizes are measured across the flat (a/f) of the nut (in mm). Available in sizes as shown on the front page.

Some sizes are also available in short and medium arrow versions.

Colour: Other colours are available subject to quantity.

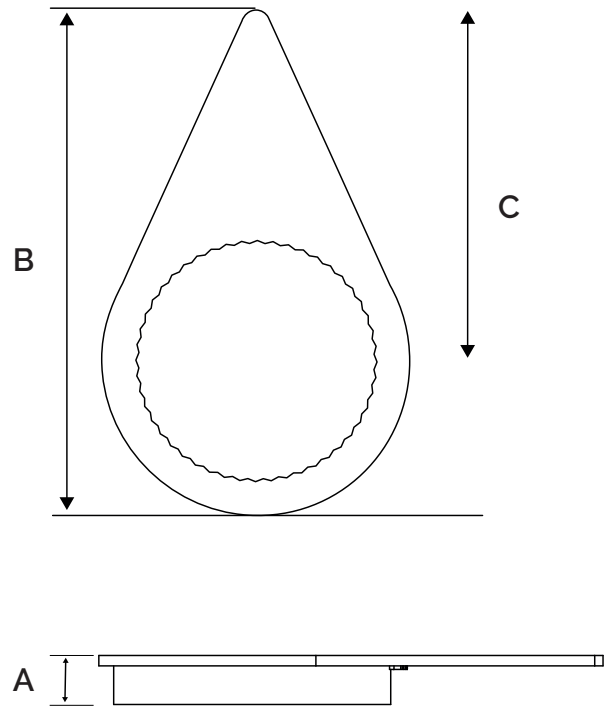

Specifications

A = 7 mm

B = 57 mm

C = 38 mm

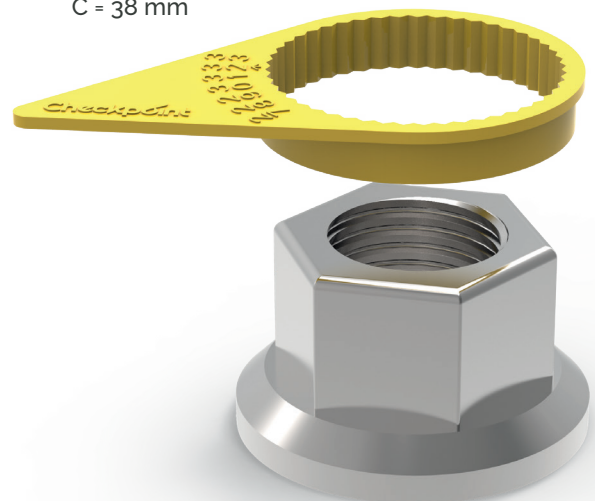

SPECIFICATIONS ARE VALID FOR ALL COLOURS IN THIS SIZE

**GLOBAL LEADERS
IN WHEEL SAFETY**

Tel: +44 (0)1524 271 200
info@checkpoint-safety.com
www.checkpoint-safety.com

Checkpoint®
THE ORIGINAL AND THE BEST